

# Spec 5 Conduit Bodies, Covers and Gaskets

For Rigid Conduit and IMC

NEC/CEC — Suitable for use in the following  
Hazardous Locations:  
Class I, Division 2 per NEC 501.10(B)(4)

## Applications

- Serve as pulling fittings.
- Make bends in conduit system.
- Provide openings for splicing.
- Connect and change direction of conduit runs.
- Allow connections for branch runs.
- Permit access to conductors for maintenance.

## Features

- Smooth, rounded integral bushings in hubs protect conductor insulation.
- Accurately tapped, tapered threads for tight, rigid joints and excellent ground continuity.
- Spec 5 malleable or ductile iron Unilets™: high tensile strength and ductility. High corrosion-resistance, high impact and shock resistance.
- Exclusive built-in easy-pulling rollers in type C (1-1/4" thru 4") and type LB (1-1/4" thru 4"): eliminate damage when cable is pulled through hubs.
- Sizes with flat-back design ideal where fitting is mounted flat against surface.
- 1/2" to 3" blank covers are domed for extra wiring space.
- Raintight when a cover and gasket are installed.

## Standard Materials

- Bodies: malleable or ductile iron
- Covers: steel, aluminum, malleable or ductile iron
- Cover screws: stainless steel
- Gaskets: neoprene or composition fiber

## Standard Finishes

- Malleable or ductile iron bodies and covers: triple-coat — (1) zinc electroplate, (2) chromate, and (3) epoxy powder coat
- Steel covers: zinc electroplate

## Options

- For additional corrosion protection, specify Hot Dip Galvanized: add suffix **-G** to malleable or ductile iron catalog number.

## NEC/CEC Certifications and Compliances

- UL Standards: 514A, 514B
- UL Listed: E2527
- CSA Standard: C22.2 No. 18.3
- CSA Certified: 065183
- NEMA Standard: FB-1

## Related Products

- For explosionproof conduit outlet bodies and boxes, see *Enclosures and Junction Boxes in Protection and Control of Electrical Apparatus and Circuits Catalog*.

## Illustrated Features

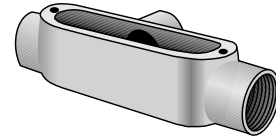

Type T

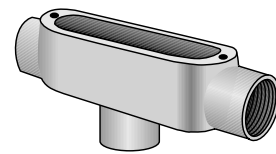

Type TB

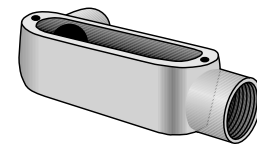

Type LL

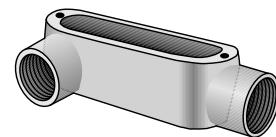

Type LR

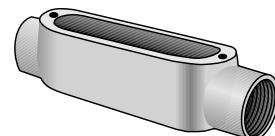

Type C

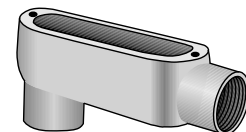

Type LB

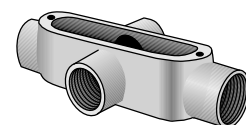

Type X

# Spec 5 Conduit Bodies, Covers and Gaskets

For Rigid Conduit and IMC

NEC/CEC — Suitable for use in the following  
Hazardous Locations:  
Class I, Division 2 per NEC 501.10(B)(4)

Trade Size (Inches)	Max. Wire Fill	C		Max. Wire Fill	LB	
		Catalog Number	Hot Dip Galvanized Catalog Number		Catalog Number	Hot Dip Galvanized Catalog Number

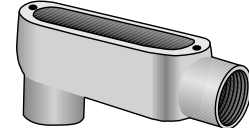
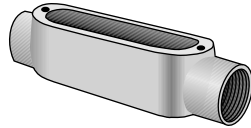

1/2	①	C-50	C-50G	①	LB-50	LB-50G
3/4	(3) # 6AWG	C-75	C-75G	(3) # 6AWG	LB-75	LB-75G
1	(3) # 4AWG	C-100	C-100G	(3) # 4AWG	LB-100	LB-100G
1-1/4	(3) # 2AWG	C-125 ②	C-125G ②	(3) # 2AWG	LB-125	LB-125G ②
1-1/2	(3) # 1/0AWG	C-150 ②	C-150G ②	(3) # 1/0AWG	LB-150	LB-150G ②
2	(3) # 4/0AWG	C-200 ②	C-200G ②	(3) # 4/0AWG	LB-200	LB-200G ②
2-1/2	(3) 300MCM	C-250 ②	C-250G ②	(3) 300MCM	LB-250	LB-250G ②
3	(3) 300MCM	C-300 ②	C-300G ②	(3) 300MCM	LB-300	LB-300G ②
3-1/2	(3) 350MCM	C-350 ②	C-350G ②	(3) 350MCM	LB-350	LB-350G ②
4	(3) 350MCM	C-400 ②	C-400G ②	(3) 350MCM	LB-400	LB-400G ②

Trade Size (Inches)	Max. Wire Fill	T		Max. Wire Fill	TB	
		Catalog Number	Hot Dip Galvanized Catalog Number		Catalog Number	Hot Dip Galvanized Catalog Number

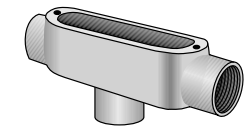
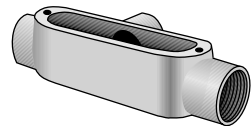

1/2	①	T-50	T-50G	①	TB-50	TB-50G
3/4	(3) # 6AWG	T-75	T-75G	(3) # 6AWG	TB-75	TB-75G
1	(3) # 4AWG	T-100	T-100G	(3) # 4AWG	TB-100	TB-100G
1-1/4	(3) # 2AWG	T-125	T-125G	(3) # 2AWG	TB-125	TB-125G
1-1/2	(3) # 1AWG	T-150	T-150G	(3) # 1AWG	TB-150	TB-150G
2	(3) # 2/0AWG	T-200	T-200G	(3) # 2/0AWG	TB-200	TB-200G
2-1/2	(3) 300MCM	T-250	T-250G	(3) 300MCM	—	—
3	(3) 300MCM	T-300	T-300G	(3) 300MCM	—	—
3-1/2	(3) 350MCM	T-350	T-350G	(3) 350MCM	—	—
4	(3) 350MCM	T-400	T-400G	(3) 350MCM	—	—

① All 1/2" Max Wire Fill Calculations per the NEC - Annex C - Table C8.

② Catalog numbers having roller feature, all others do not.

# Spec 5 Conduit Bodies, Covers and Gaskets

For Rigid Conduit and IMC

NEC/CEC — Suitable for use in the following  
Hazardous Locations:  
Class I, Division 2 per NEC 501.10(B)(4)

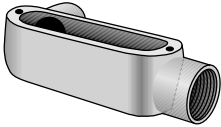
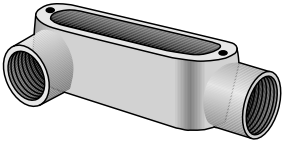
Trade Size (Inches)	Max. Wire Fill	LL		Max. Wire Fill	LR	
		Catalog Number	Hot Dip Galvanized Catalog Number		Catalog Number	Hot Dip Galvanized Catalog Number
						
1/2	①	<b>LL-50</b>	<b>LL-50G</b>	①	<b>LR-50</b>	<b>LR-50G</b>
3/4	(3) # 6AWG	<b>LL-75</b>	<b>LL-75G</b>	(3) # 6AWG	<b>LR-75</b>	<b>LR-75G</b>
1	(3) # 4AWG	<b>LL-100</b>	<b>LL-100G</b>	(3) # 4AWG	<b>LR-100</b>	<b>LR-100G</b>
1-1/4	(3) # 2AWG	<b>LL-125</b>	<b>LL-125G</b>	(3) # 2AWG	<b>LR-125</b>	<b>LR-125G</b>
1-1/2	(3) # 1/0AWG	<b>LL-150</b>	<b>LL-150G</b>	(3) # 1/0AWG	<b>LR-150</b>	<b>LR-150G</b>
2	(3) # 4/0AWG	<b>LL-200</b>	<b>LL-200G</b>	(3) # 4/0AWG	<b>LR-200</b>	<b>LR-200G</b>
2-1/2	(3) 300MCM	<b>LL-250</b>	<b>LL-250G</b>	(3) 300MCM	<b>LR-250</b>	<b>LR-250G</b>
3	(3) 350MCM	<b>LL-300</b>	<b>LL-300G</b>	(3) 350MCM	<b>LR-300</b>	<b>LR-300G</b>
3-1/2	(3) 350MCM	<b>LL-350</b>	<b>LL-350G</b>	(3) 350MCM	<b>LR-350</b>	<b>LR-350G</b>
4	(3) 350MCM	<b>LL-400</b>	<b>LL-400G</b>	(3) 350MCM	<b>LR-400</b>	<b>LR-400G</b>

OZ/GEDNEY™

COMMERCIAL AND INDUSTRIAL FITTINGS: CONDUIT BODIES

① All 1/2" Max Wire Fill Calculations per the NEC - Annex C - Table C8.

# Spec 5 Conduit Bodies, Covers and Gaskets

For Rigid Conduit and IMC

NEC/CEC — Suitable for use in the following  
Hazardous Locations:  
Class I, Division 2 per NEC 501.10(B)(4)

## Applications

- To provide access to conductors for pulling, splicing, maintenance and future changes/ upgrades.
- Allows connection of straight conduit runs, branch conduit runs and 90° bends.
- Conduit bodies are suitable for use in Class I, Division 2 hazardous locations per NEC Section 501-4(B).

## Features

- Tapered threaded hubs (NPT).
- Packaged complete with cover and gasket under one catalog number.
- Ready to use.

## Standard Materials

- Bodies: malleable or ductile iron
- Covers: steel, aluminum, malleable or ductile iron
- Cover screws: stainless steel
- Gaskets: neoprene or composition fiber

## Standard Finishes

- Malleable or ductile iron bodies and covers: triple-coat — (1) zinc electroplate, (2) chromate, and (3) epoxy powder coat
- Steel covers: zinc electroplated

## NEC/CEC Certifications and Compliances

- UL Standard: 514A
- UL Listed: E-18095
- CSA Standard: C22.2 No. 18
- CSA Certified: 009795
- Fed Spec: A-A-50563
- NEMA: FB-1, FB-2.10

## Illustrated Features

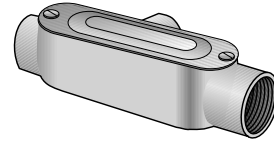

Type T-CG



Type TB-CG

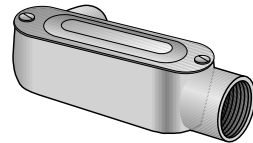

Type LL-CG

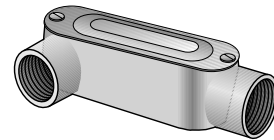

Type LR-CG

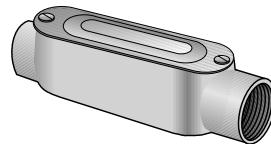

Type C-CG

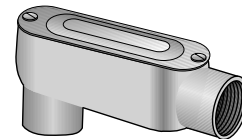

Type LB-CG





Type X-CG

# Spec 5 Conduit Bodies, Covers and Gaskets

For Rigid Conduit and IMC

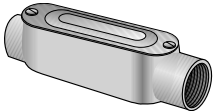
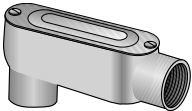
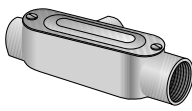
NEC/CEC — Suitable for use in the following  
Hazardous Locations:  
Class I, Division 2 per NEC 501.10(B)(4)

Trade Size (Inches)	C-CG		LB-CG		T-CG	
	Max. Wire Fill	Catalog Number	Max. Wire Fill	Catalog Number	Max. Wire Fill	Catalog Number
						
1/2	①	<b>C-50CG</b>	①	<b>LB-50CG</b>	①	<b>T-50CG</b>
3/4	(3) # 6AWG	<b>C-75CG</b>	(3) # 6AWG	<b>LB-75CG</b>	(3) # 6AWG	<b>T-75CG</b>
1	(3) # 4AWG	<b>C-100CG</b>	(3) # 4AWG	<b>LB-100CG</b>	(3) # 4AWG	<b>T-100CG</b>
1-1/4	(3) # 2AWG	<b>C-125CG</b>	(3) # 2AWG	<b>LB-125CG</b>	(3) # 2AWG	<b>T-125CG</b>
1-1/2	(3) # 1/0AWG	<b>C-150CG</b>	(3) # 1/0AWG	<b>LB-150CG</b>	(3) # 1AWG	<b>T-150CG</b>
2	(3) # 4/0AWG	<b>C-200CG</b>	(3) # 4/0AWG	<b>LB-200CG</b>	(3) # 2/0AWG	<b>T-200CG</b>

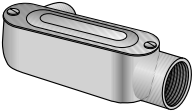
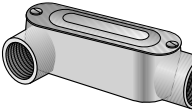
Trade Size (Inches)	TB-CG		LL-CG		LR-CG	
	Max. Wire Fill	Catalog Number	Max. Wire Fill	Catalog Number	Max. Wire Fill	Catalog Number
						
1/2	①	<b>TB-50CG</b>	①	<b>LL-50CG</b>	①	<b>LR-50CG</b>
3/4	(3) # 6AWG	<b>TB-75CG</b>	(3) # 6AWG	<b>LL-75CG</b>	(3) # 6AWG	<b>LR-75CG</b>
1	(3) # 4AWG	<b>TB-100CG</b>	(3) # 4AWG	<b>LL-100CG</b>	(3) # 4AWG	<b>LR-100CG</b>
1-1/4	(3) # 2AWG	<b>TB-125CG</b>	(3) # 2AWG	<b>LL-125CG</b>	(3) # 2AWG	<b>LR-125CG</b>
1-1/2	(3) # 1AWG	<b>TB-150CG</b>	(3) # 1/0AWG	<b>LL-150CG</b>	(3) # 1/0AWG	<b>LR-150CG</b>
2	(3) # 2/0AWG	<b>TB-200CG</b>	(3) # 4/0AWG	<b>LL-200CG</b>	(3) # 4/0AWG	<b>LR-200CG</b>

Trade Size (Inches)	X-CG	
	Max. Wire Fill	Catalog Number
		
1/2	①	<b>X-50CG</b>
3/4	(3) # 6AWG	<b>X-75CG</b>
1	(3) # 4AWG	<b>X-100CG</b>
1-1/4	(3) # 4AWG	<b>X-125CG</b>
1-1/2	(3) 1/0AWG	<b>X-150CG</b>
2	(3) 2/0AWG	<b>X-200CG</b>

① All 1/2" Max Wire Fill Calculations per the NEC - Annex C - Table C8.

# Spec 5 Conduit Bodies, Covers and Gaskets

For Rigid Conduit and IMC

NEC/CEC — Suitable for use in the following  
 Hazardous Locations:  
 Class I, Division 2 per NEC 501.10(B)(4)

## Wiring Capacity: Combine Body and Cover Capacities for Total Usable Capacity per NEC 314.16(A)

Hub Size (Inches)	Capacity dm <sup>3</sup> (in <sup>3</sup> )									Stamped Cover	Cast Cover
	C	E	LB	LL & LR	LRL	T	TA	TB	X		
1/2	0.07 (4.50)	0.07 (4.50)	0.07 (4.50)	0.07 (4.50)	0.08 (5.00)	0.10 (6.00)	0.07 (4.30)	0.07 (4.30)	0.10 (6.00)	0.01 (0.50)	0.00 (0.00)
3/4	0.12 (7.50)	0.12 (7.50)	0.12 (7.50)	0.12 (7.50)	0.14 (8.80)	0.16 (9.50)	0.11 (7.00)	0.11 (7.00)	0.16 (9.50)	0.01 (0.80)	0.00 (0.30)
1	0.20 (12.50)	0.20 (12.50)	0.20 (12.50)	0.20 (12.50)	0.23 (14.30)	0.25 (15.00)	0.25 (15.00)	0.21 (13.00)	0.25 (15.00)	25.4 (1.00)	0.01 (0.50)
1-1/4	0.57 (35.00)	0.48 (29.30)	0.53 (32.30)	0.52 (32.00)	0.57 (34.80)	0.54 (33.00)	—	0.57 (35.00)	0.52 (31.50)	0.04 (2.50)	0.01 (0.80)
1-1/2	0.58 (35.30)	0.53 (32.50)	0.58 (35.30)	0.58 (35.30)	0.66 (40.00)	0.59 (36.00)	—	0.58 (35.30)	0.66 (40.00)	0.04 (2.50)	0.01 (0.80)
2	1.23 (75.00)	—	1.20 (73.00)	1.20 (73.00)	1.39 (85.00)	1.16 (71.00)	—	1.16 (71.00)	1.16 (71.00)	0.11 (6.50)	0.02 (1.00)
2-1/2	2.34 (143.00)	—	2.28 (139.00)	2.30 (140.50)	—	2.39 (146.00)	—	—	—	0.29 (18.00)	0.49 (30.00)
3	2.95 (180.00)	—	2.90 (177.00)	2.87 (175.00)	—	3.03 (185.00)	—	—	—	0.29 (18.00)	0.49 (30.00)
3-1/2	4.97 (303.00)	—	4.92 (300.00)	4.92 (300.00)	—	5.15 (314.00)	—	—	—	—	0.82 (50.00)
4	5.57 (340.00)	—	5.41 (330.00)	5.41 (330.00)	—	5.65 (345.00)	—	—	—	—	0.82 (50.00)
5	—	—	12.39 (756.00)	—	—	—	—	—	—	—	—
6	—	—	21.76 (1328.00)	—	—	—	—	—	—	—	—

OZ/GEDNEY™

COMMERCIAL AND INDUSTRIAL FITTINGS: CONDUIT BODIES

# Spec 5 Conduit Bodies, Covers and Gaskets

For Spec 5 Conduit Outlet Bodies.

NEC/CEC — Suitable for use in the following  
Hazardous Locations:  
Class I, Division 2 per NEC 501.10(B)(4)

## Blank Covers and Gaskets

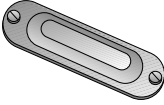
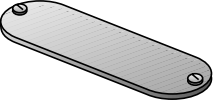
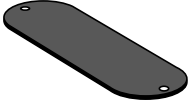
Body Size (Inches)	Domed Top Design Steel Cover	Flat Top Design Iron Cover	Solid Cover Sealing Gasket	
			Velbuna	Neoprene
				
1/2	<b>BS-50S</b>	<b>BC-50G</b>	<b>SG-50</b>	<b>SGN-50</b>
3/4	<b>BS-75S</b>	<b>BC-75G</b>	<b>SG-75</b>	<b>SGN-75</b>
1	<b>BS-100S</b>	<b>BC-100G</b>	<b>SG-100</b>	<b>SGN-100</b>
1-1/4 - 1-1/2	<b>BS-125S</b>	<b>BC-125G</b>	<b>SG-125</b>	<b>SGN-125</b>
2	<b>BS-200S</b>	<b>BC-200G</b>	<b>SG-200</b>	<b>SGN-200</b>
2-1/2 - 3	<b>BS-250S</b>	<b>BC-250G</b>	<b>SG-250</b>	<b>SGN-250</b>
3-1/2 - 4	<b>BS-350S</b> <sup>①</sup>	<b>BC-350G</b>	<b>SG-350</b>	<b>SGN-350</b>

<sup>①</sup> Flat Top Design Cover

# Spec 5 Conduit Bodies, Covers and Gaskets

For Rigid Conduit and IMC

NEC/CEC — Suitable for use in the following  
Hazardous Locations:  
Class I, Division 2 per NEC 501.10(B)(4)

## Threaded Type Dimensions in Millimeters (Inches)

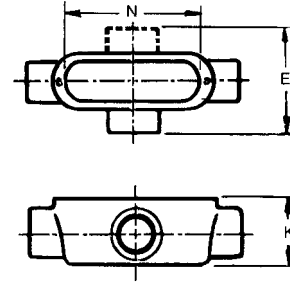
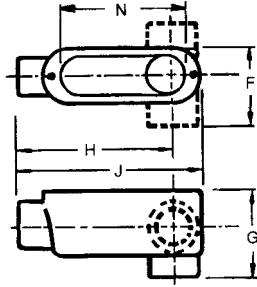
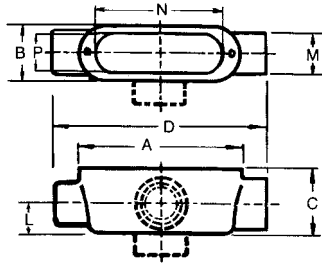

Types A, C, TA, TB

Types E, LB, LL, LR, LRL

Types T, X

Hub Size	A	B	C	D	E	F	G	H	J	K	L	M	N	P
1/2	100.1 (3.94)	33.3 (1.31)	36.6 (1.44)	136.7 (5.38)	68.3 (2.69)	50.8 (2.00)	54.1 (2.13)	100.1 (3.94)	117.6 (4.63)	44.5 (1.75)	16.0 (0.63)	30.2 (1.19)	80.3 (3.16)	25.4 (1.00)
3/4	117.6 (4.63)	39.6 (1.56)	42.9 (1.69)	153.9 (6.06)	73.2 (2.88)	55.6 (2.19)	58.7 (2.31)	112.8 (4.44)	136.7 (5.38)	50.8 (2.00)	19.1 (0.75)	35.1 (1.38)	96.0 (3.78)	31.0 (1.22)
1	136.7 (5.38)	46.0 (1.81)	49.3 (1.94)	181.1 (7.13)	85.9 (3.38)	65.0 (2.56)	68.3 (2.69)	130.3 (5.13)	158.8 (6.25)	57.2 (2.25)	23.9 (0.94)	42.9 (1.69)	115.1 (4.53)	37.3 (1.47)
1-1/4	182.6 (7.19)	63.5 (2.50)	65.0 (2.56)	233.4 (9.19)	114.3 (4.50)	88.9 (3.50)	90.4 (3.56)	179.3 (7.06)	208.0 (8.19)	65.0 (2.56)	30.2 (1.19)	50.8 (2.00)	152.4 (6.00)	50.8 (2.00)
1-1/2	182.6 (7.19)	63.5 (2.50)	69.9 (2.75)	233.4 (9.19)	114.3 (4.50)	88.9 (3.50)	95.3 (3.75)	173.0 (6.81)	208.0 (8.19)	69.9 (2.75)	35.1 (1.38)	60.5 (2.38)	152.4 (6.00)	50.8 (2.00)
2	241.3 (9.50)	79.5 (3.13)	85.9 (3.38)	295.4 (11.63)	133.4 (5.25)	106.4 (4.19)	117.6 (4.63)	227.1 (8.94)	268.2 (10.56)	85.9 (3.38)	41.4 (1.63)	74.7 (2.94)	204.7 (8.06)	65.0 (2.56)
2-1/2	311.2 (12.25)	109.5 (4.31)	98.6 (3.88)	384.3 (15.13)	—	146.1 (5.75)	133.4 (5.25)	301.8 (11.88)	347.7 (13.69)	98.6 (3.88)	46.0 (1.81)	85.9 (3.38)	270.0 (10.63)	93.7 (3.69)
3	311.2 (12.25)	109.5 (4.31)	117.6 (4.63)	384.3 (15.13)	—	146.1 (5.75)	152.4 (6.00)	293.6 (11.56)	347.7 (13.69)	117.6 (4.63)	55.6 (2.19)	104.9 (4.13)	270.0 (10.63)	93.7 (3.69)
3-1/2	378.0 (14.88)	139.7 (5.50)	131.8 (5.19)	460.5 (18.13)	—	181.1 (7.13)	173.0 (6.81)	355.6 (14.00)	419.1 (16.50)	131.8 (5.19)	63.5 (2.50)	120.7 (4.75)	333.5 (13.13)	124.0 (4.88)
4	378.0 (14.88)	139.7 (5.50)	141.2 (5.56)	460.5 (18.13)	—	181.1 (7.13)	182.6 (7.19)	349.3 (13.75)	419.1 (16.50)	141.2 (5.56)	69.9 (2.75)	130.3 (5.13)	333.5 (13.13)	124.0 (4.88)
5	463.6 (18.25)	184.2 (7.25)	177.8 (7.00)	—	—	—	228.6 (9.00)	428.8 (16.88)	514.4 (20.25)	—	85.9 (3.38)	165.1 (6.50)	412.8 (16.25)	165.1 (6.50)
6	584.2 (23.00)	219.2 (8.63)	220.7 (8.69)	—	—	—	271.5 (10.69)	534.9 (21.06)	635.0 (25.00)	—	100.1 (3.94)	192.0 (7.56)	533.4 (21.00)	198.4 (7.81)

OZ/GEDNEY

COMMERCIAL AND INDUSTRIAL FITTINGS: CONDUIT BODIES