

RS Series Malleable Iron Junction Boxes

Hub Plates in Four Styles

UNILETS™ for Use with Threaded Rigid Metal Conduit and IMC.

NEC/CEC:

Rated for Ordinary (Unclassified) Locations

Applications

- Serve as main cable distribution center, or can be used for adding circuits to existing systems.
- Serve as pull boxes.
- Provide access to conductors for maintenance.

Features

- Removable hub covers permit variable hub arrangements in a wide range of sizes.
- Furnished with top cover, gaskets, and cover screws for all open sides.
- Side covers available blank or with 1, 2, or 3 hubs.
- Provides visibility while making connections and splices (opens on four sides and top).
- Threads are accurately tapped and tapered for tight, rigid joints and ground continuity.
- Hubs in all covers have integral bushings to protect conductor insulation from damage. Hub plate openings are smooth.

Standard Materials

- RS boxes and covers: malleable iron.
- Gaskets: composition fiber.

Standard Finishes

- RS boxes and covers: triple coat – (1) zinc electroplate, (2) chromate, and (3) epoxy powder coat.

NEC/CEC Compliances and Compliances

- UL Standard: 50, 50E
- CSA Standard: C22.2 No. 40

Dimensions in Millimeters (Inches)

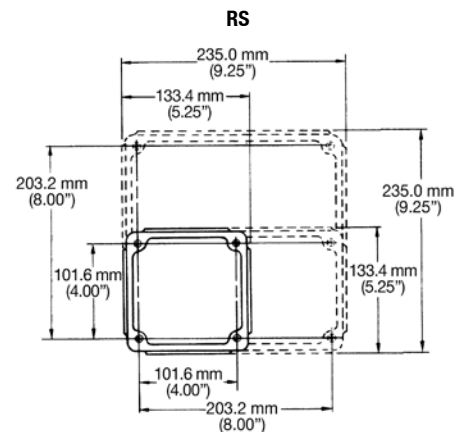
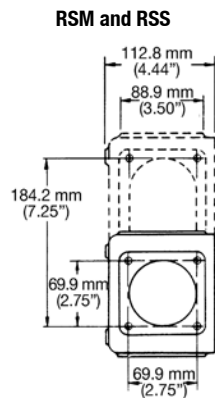

RS Box bottom and side frame construction is one piece malleable iron. Smooth hub cover openings prevent damage to conductor insulation.











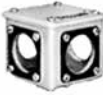

RE Junction Boxes come in three sizes, furnished with top cover, gaskets and cover screws for all open sides.

RS Series Malleable Iron Junction Boxes

Hub Plates in Four Styles

UNILETS™ for Use with Threaded Rigid Metal Conduit and IMC.

NEC/CEC:
Rated for Ordinary (Unclassified) Locations

Description		Size (Inches)	Catalog Number
RS – Boxes – Furnished with top gasketed cover plus screws and gaskets for open sides			
	RS	8-1/2 x 8-1/2 x 4 <i>Inside Dimensions</i>	RS-1
	RSM	8-1/2 x 4-1/2 x 4 <i>Inside Dimensions</i>	RSM-1
	RSS	4-1/2 x 4-1/2 x 4 <i>Inside Dimensions</i>	RSS-1
RS, RSM – Covers for 8-1/2" x 4" Sides – Gaskets and Screws Not Included			
	One Hub	1/2	RSK1-50
		3/4	RSK1-75
		1	RSK1-100
		1-1/4	RSK1-125
		1-1/2	RSK1-150
		2	RSK1-200
	Two Hubs	1/2	RSK2-50
		3/4	RSK2-75
		1	RSK2-100
		1-1/4	RSK2-125
		1-1/2	RSK2-150
		2	RSK2-200
	Three Hubs	1/2	RSK3-50
		3/4	RSK3-75
		1	RSK3-100
		1-1/4	RSK3-125
	Blank	Blank	RSK-B
RSS, RSM – Covers for 4-1/2" x 4" Sides – Gaskets and Screws Not Included			
	One Hub	1/2	RSSK-50
		3/4	RSSK-75
		1	RSSK-100
		1-1/4	RSSK-125
		1-1/2	RSSK-150
		2	RSSK-200
	Blank	Blank	RSSK-B
Gaskets – Composition Fiber			
	For RS, RSM 8-1/2" x 4" Sides		RS-GK
	For RSM, RSS 4-1/2" x 4" Sides		RSS-GK